



JEWEL HILL ELECTRONIC CO.,LTD.



JEWEL HILL ELECTRONIC CO.,LTD.

**SPECIFICATIONS FOR
LCD MODULE**

Module No. JH395320480D

E-mail: sales@jhlcd.com

Website: www.jhlcd.com



TABLE OF CONTENTS

LCM NUMBER SYSTEM

1.GEBERAL DESCRIPTIONG.....
2.GENERAL FEATURES.....
3. ABSOLUTE MAXIMUM RATINGS.....
4. ELECTRICAL SPECIFICATIONS.....
5. OPTICAL SPECIFICATIONS.....
6. BLOCK DIAGRAM.....
7. PIN DESCRIPTION.....
8. OUTLINE DIMENSION.....
9. TIMING CHARACTERISTICS.....
10. RELIABILITY AND INSPECTION STANDARD.....
11. INSPECTION CRITERION.....
12. PACKAGE INFORMATION.....
13. ROHS COMPLIANT WARRANTY.....
14. PRECAUTIONS FOR USE.....
15. REVISION HISTORY.....
SAMPLE APPROVED REPORT	

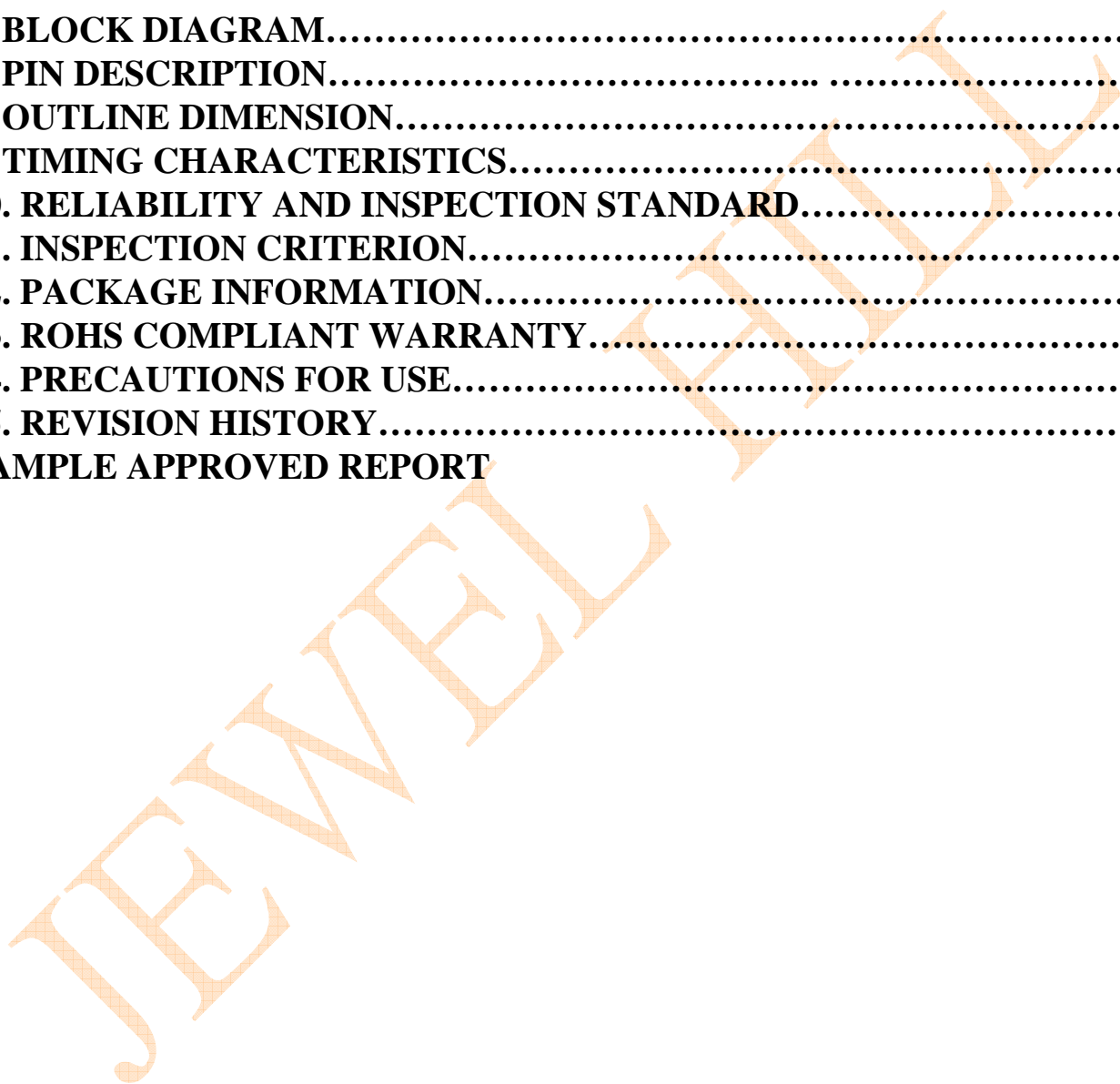



LCM Number System

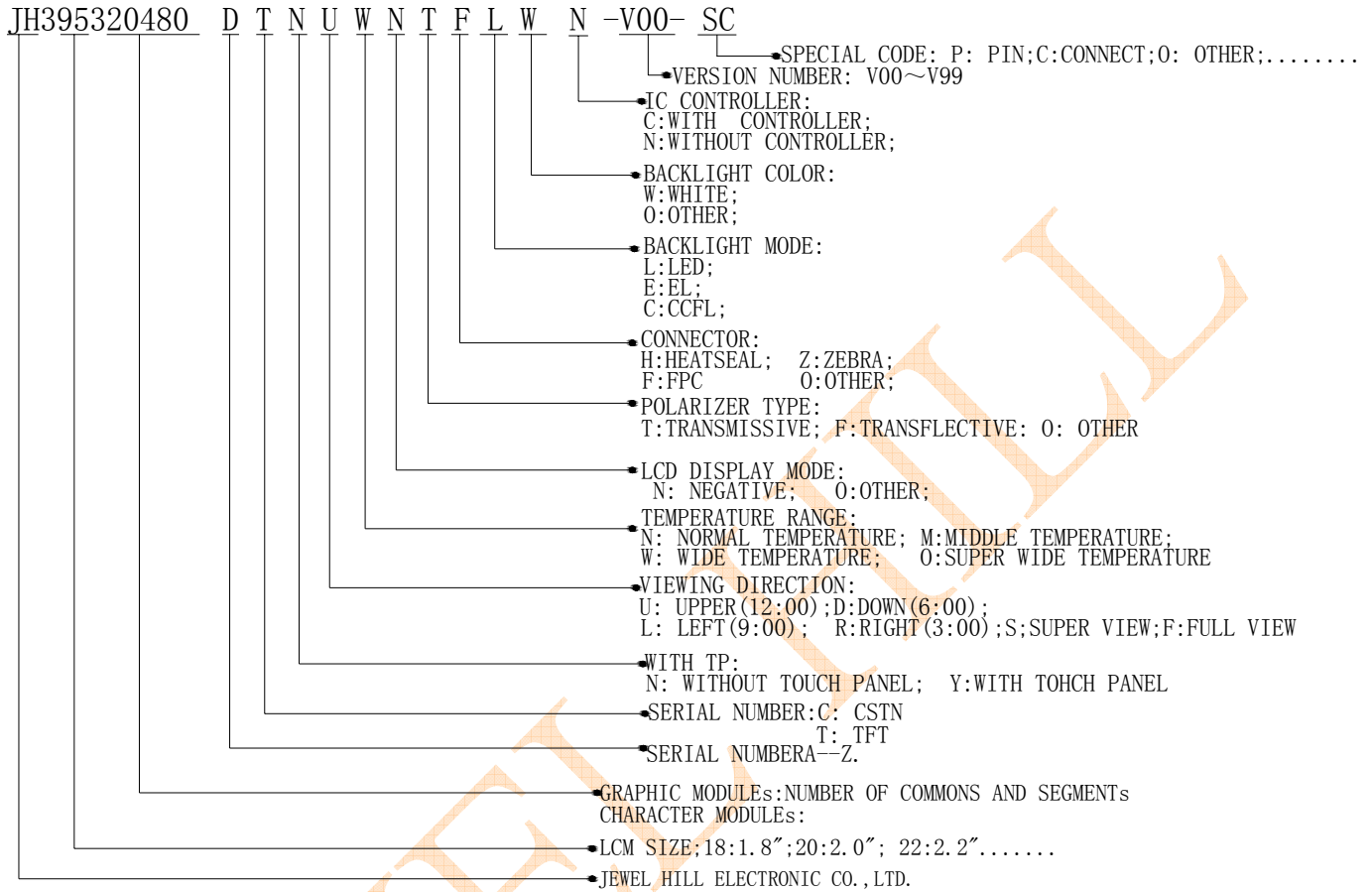



1. GENERAL DESCRIPTION.

The JH395320480D model is a Color TFT LCD. This main Module has a **3.95**inch diagonally measured active display area with 320(RGB)×480 resolution. Each pixel is divided into Red, Green and Blue sub-pixels and dots which are arranged in vertical stripes.

The LCD color is determined with 262,000 colors signal for each pixel.

The JH395320480D has been designed to apply the interface method that enables low power, high speed, and high contrast.

The JH395320480D is intended to support applications where thin thickness, wide viewing angle and low power are critical factors and graphic displays are important.

2. GENERAL FEATURES.

Item	Display Panel	Remark
Display Mode	Normally White, Transmissive LCD	
Viewing Direction	12 O'Clock	
Input Signals	16BIT	
Outside Dimensions	60.88(W)*94.57(H)*2.28(T)	
Effective Area	-	
Active Area	55.68mm(W)×83.52mm(H)	
Number of Pixels	320×RGB×480Pixels	
Pixel Pitch	0.174mm(H) × 0.174mm(W)	
Pixel Arrangement	RGB Vertical stripes	
Drive IC	ILI9486L	

3. Absolute Maximum Ratings

The following are maximum values which, if exceeded may cause operation or damage to the unit.

ITEM	Symbol	Min.	Typ.	Max.	Unit	Remark
Power for Circuit Driving	VDD	-0.3	-	3.3	V	
Power for Circuit Logic	VCI	-0.3	-	4.6	V	
LC Operating Voltage *1)	Vop		-		V	
25.6	V _f	3.0	3.2	3.4	V	
LED Forward Current	I _f	110	120	130	mA	
LED Luminance	B _p	4000	-	-	cd/m ²	
Storage Humidity	H _{ST}	10	-	90	%RH	At 25±5°C
Storage Temperature	T _{ST}	-30	-	80	°C	
Operating Ambient Humidity	H _{OP}	10	-	90	%RH	
Operating Ambient temperature	T _{OP}	-20	-	70	°C	

Note:

- *1) Liquid Crystal driving voltage.
Due to the characteristics of LC Material, this voltage vary with environmental temperature.
- *2) Temp. >60°C, Absolute humidity shall be less than 90%RH at 60°C
- *3) Temp. ≤60°C, 90%RH MAX.

4. Electrical Specification Main Window Display

(Unless specified, the ambient temperature Ta=25°C)

Properties		Sym.	Min	Typ.	Max	Unit	Note
Power for Circuit Driving		VDD	1.65	2.8	3.3	V	Note
Power for Circuit Logic		VCI	2.7	2.8	4.6	V	Note
BLU Driving Logic		Vbat	-	-	-	V	
Logic Input Voltage	Low Voltage	VIL	0	-	0.2VDD	V	
	High Voltage	VIH	0.8VDD	-	VDD	V	
Logic Output Voltage	Low Voltage	VOL	0	-	0.1VDD	V	
	High Voltage	VOH	0.9VDD	-	VDD	V	
Power Consumption	White	P _w	T.B.D	T.B.D	T.B.D	mW	
	Black	P _b	T.B.D	T.B.D	T.B.D	mW	
	Vertical Stripe	P _v	T.B.D	T.B.D	T.B.D	mW	

Note:

The recommended operating conditions refer to a range in which operation of this product is guaranteed. Should this range is exceeded, the operation cannot be guaranteed even if the values may be without the absolute maximum ratings.

Accordingly, please make sure that the module is used within this range. And these current values are measured under the condition that all devices are stopped, each component is stable and logic signal is input.



5.Optical Specification.

Item		Symbol	Conditions	Specifications			Unit	Note
				Min.	Typ.	Max.		
Transmittance		T%	Viewing normal angle $\theta_x = \theta_y = 0^\circ$	4.7			%	All left side data are based on CMO's following condition -- NTSC: 60% Light : C light (Machine:BM5A) Normal Polarizer Reference Only
Contrast Ratio		CR		150	250	-	-	
Response Time		T_R		-	10	20	ms	
		T_F		-	20	30	ms	
Chromaticity	Red	X_R		0.604	0.634	0.664	-	
		Y_R		0.296	0.326	0.356	-	
	Green	X_G		0.260	0.290	0.320	-	
		Y_G		0.551	0.581	0.611	-	
	Blue	X_B	0.102	0.132	0.162	-		
		Y_B	0.096	0.126	0.156	-		
White	X_W	0.262	0.292	0.322	-			
	Y_W	0.306	0.336	0.366	-			
Viewing Angle	Hor.	θ_{x+}	-	45	-	deg.		
		θ_{x-}	-	45	-			
	Ver.	θ_{y+}	-	35	-			
		θ_{y-}	-	15	-			

*Note (1) Definition of Contrast Ratio (CR):

The contrast ratio can be calculated by the following expression.



Note 1: Definition of optical measurement system.

The optical characteristics should be measured in dark room. After 5 minutes operation, the optical properties are measured at the center point of the LCD screen. All input terminals LCD panel must be ground when measuring the center area of the panel.

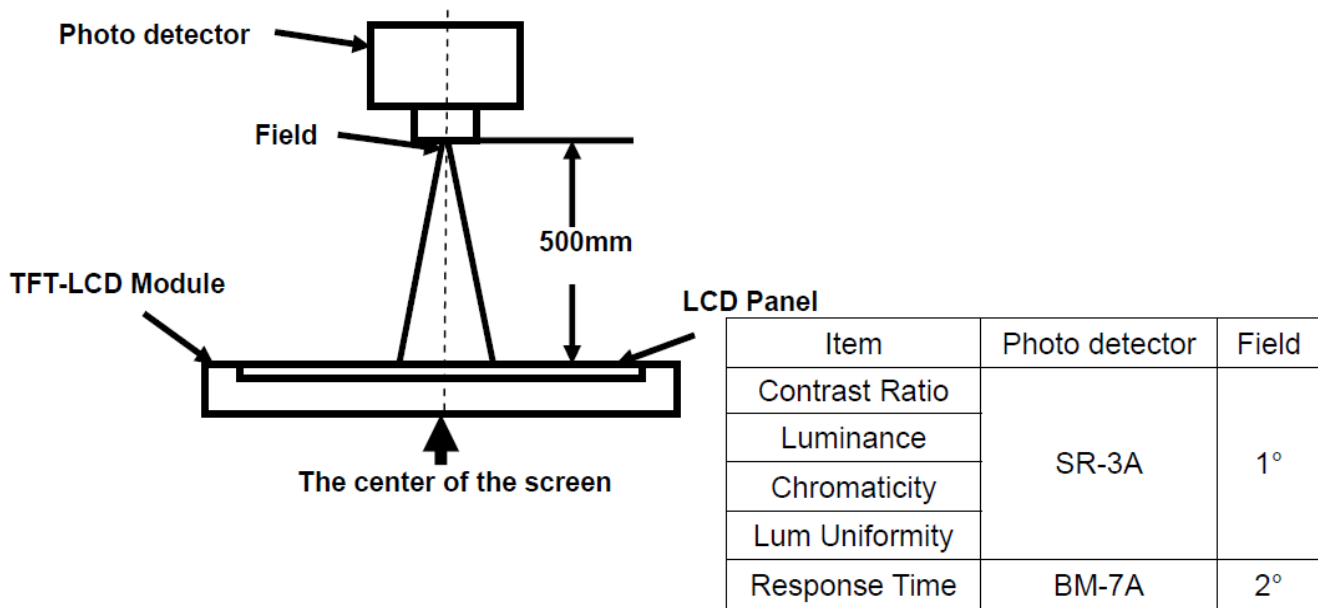

Note 2: Definition of viewing angle range and measurement system.

viewing angle is measured at the center point of the LCD by CONOSCOPE(ergo-80).

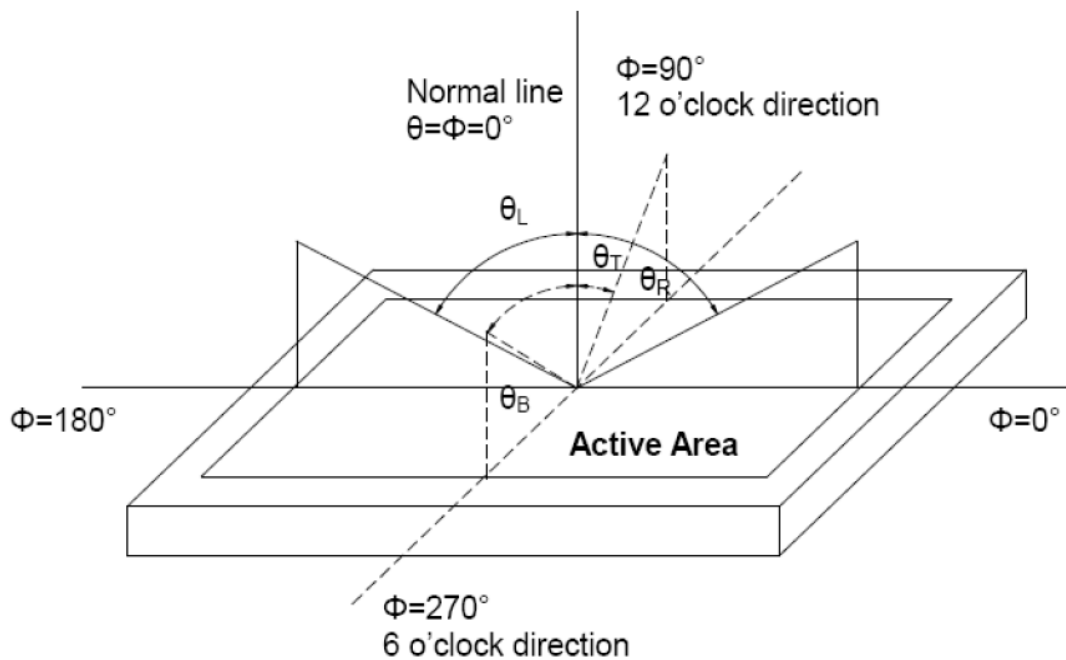

Fig. 1 Definition of viewing angle

Note 3: Definition of contrast ratio

$$\text{Contrast ratio (CR)} = \frac{\text{Luminance measured when LCD is on the "White" state}}{\text{Luminance measured when LCD is on the "Black" state}}$$

“White state “:The state is that the LCD should driven by Vwhite.

“Black state”: The state is that the LCD should driven by Vblack.

Vwhite: To be determined Vblack: To be determined.

Note 4: Definition of Response time

The response time is defined as the LCD optical switching time interval between “White” state and “Black” state. Rise time (TON) is the time between photo detector output intensity changed from 90% to 10%. And fall time (TOFF) is the time between photo detector output intensity changed from 10% to 90%.

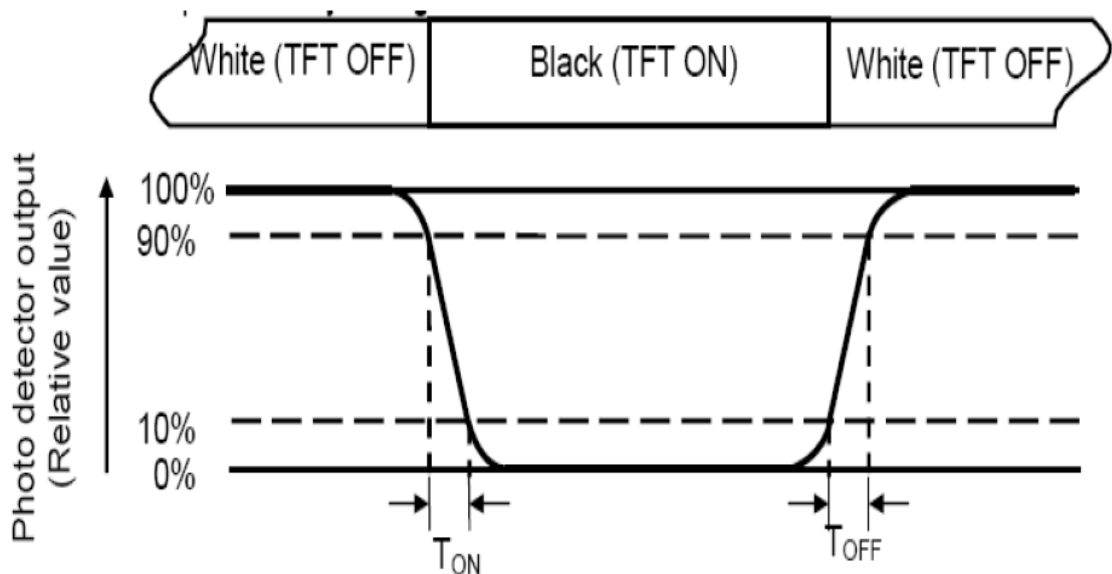

Note 5: Definition of color chromaticity (CIE1931)

Color coordinates measured at center point of LCD.

6.Block Diagram.

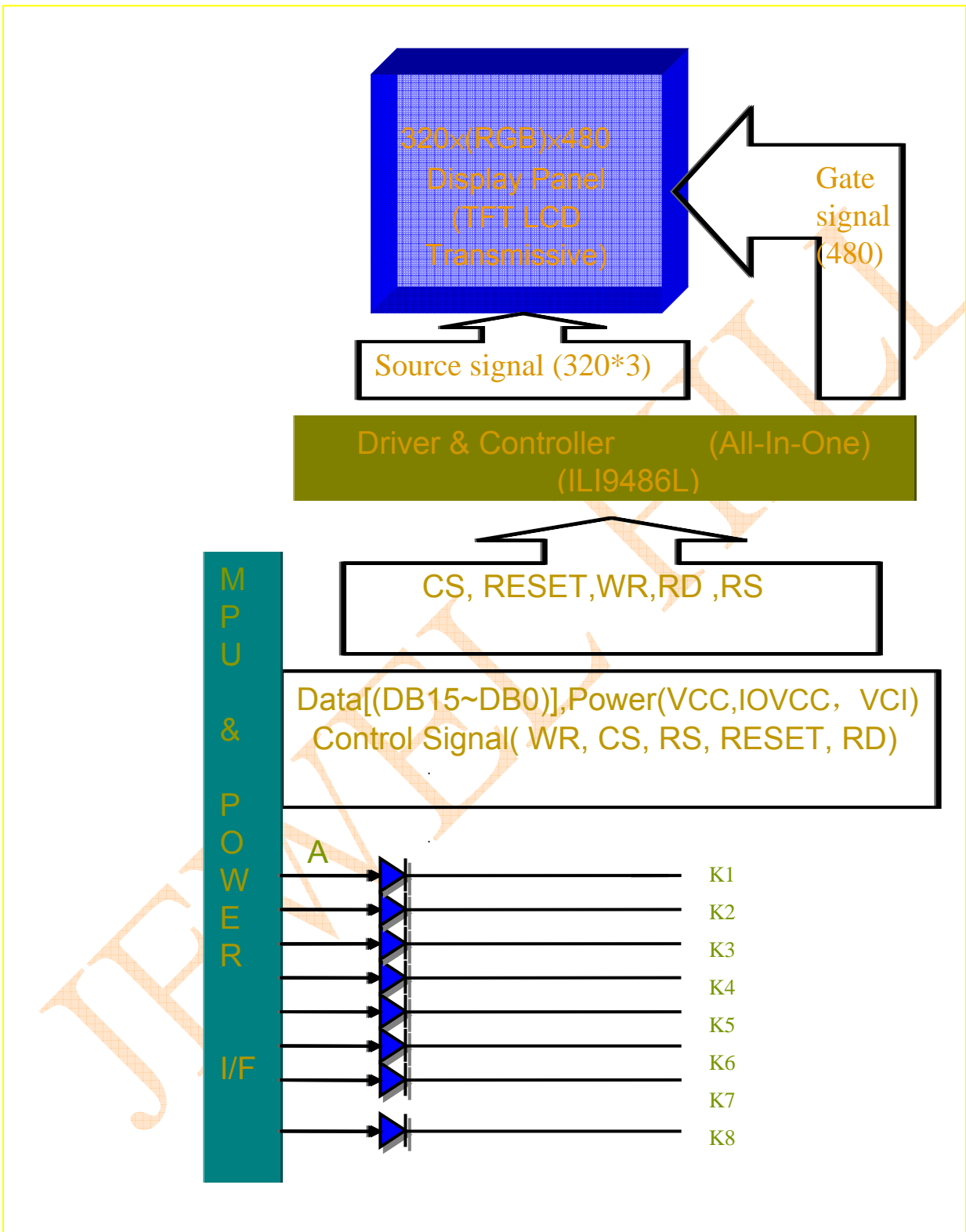



7.Pin Description

Pin NO.	Symbol	Description
1	GND	Ground
2	VCI	Power Supply2.8V
3	IOVCC	Power Supply(2.8V/1.8V)
4	CS	Chip select input pin
5	RS	Data/Command Write Select pin
6	WR	Write execution control pin
7	RD	Read execution control pin
8	RESET	System Reset Pin
9-24	DB0- DB15	Data Bus
25	FMARK	FMARK
26	GND	Ground
27	YD	Touch panel down side(NC)
28	XR	Touch panel Right side(NC)
29	YU	Touch panel Up side(NC)
30	XL	Touch panel Left side(NC)
31	GND	Ground
32	LED_A	LED+
33	LED_K1	LED-
34	LED_K2	LED-
35	LED_K3	LED-
36	LED_K4	LED-
37	LED_K5	LED-
38	LED_K6	LED-
39	LED_K7	LED-
40	LED_K8	LED-
41	GND	Ground
42	GND	Ground

8.Outline Dimension.

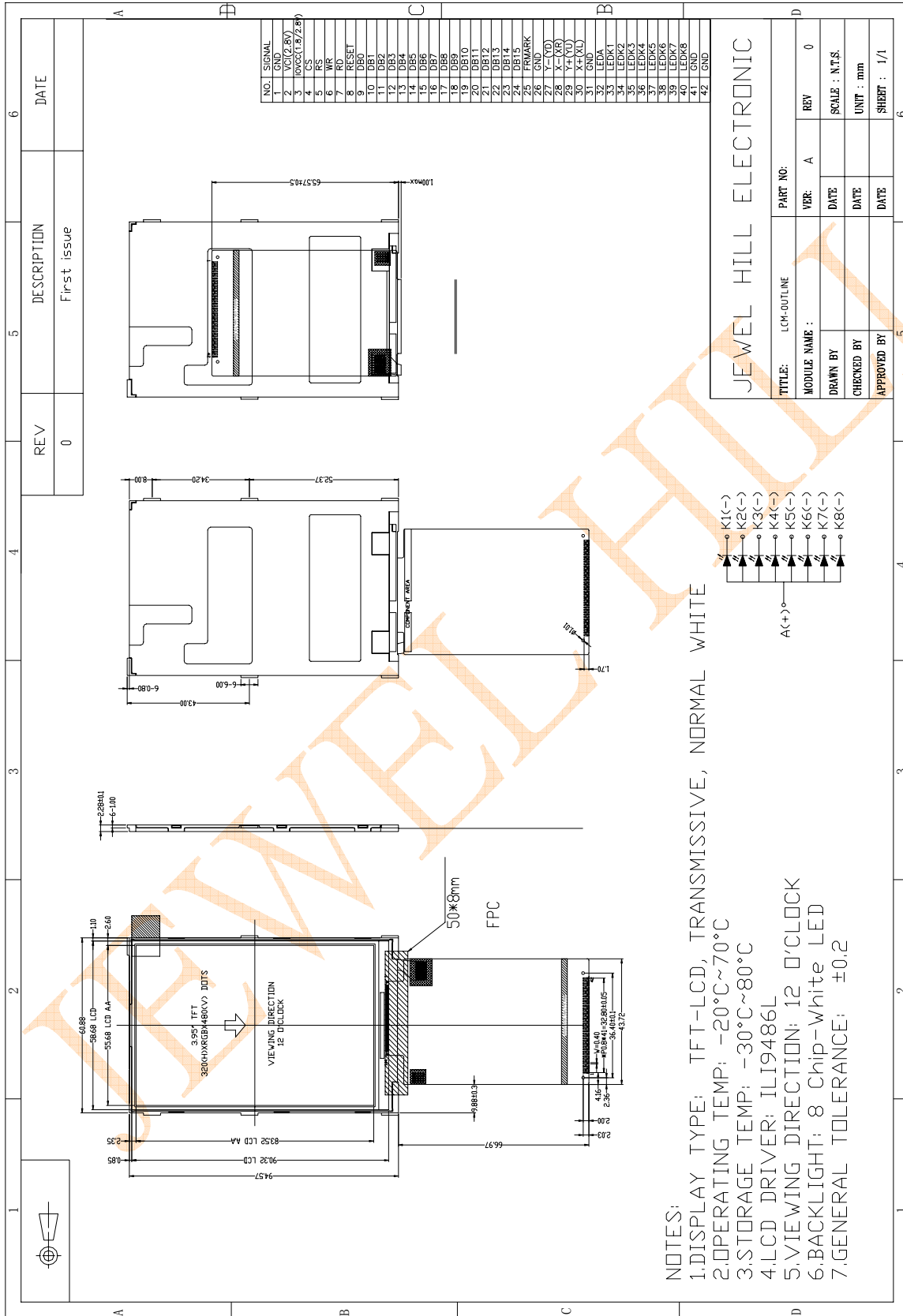

(VCC=1.65~3.1 V)

Table 13-6

Item	Symbol	Unit	Min.	Typ.	Max.
Reset low-level width	tRES	ms	1	—	—
Reset rise time	trRES	μs	—	—	10

10. Reliability and Inspection Standard

No.	Test Item	Test Conditions	Remark	
1	High Temperature	Storage	80°C, 120Hr	Note
		Operation	70°C, 120Hr	Note
2	Low Temperature	Storage	-30°C, 120Hr	Note
		Operation	-20°C, 120Hr	
3	High Temperature and High Humidity	60°C, 90%RH, 120Hr	Note	
4	Temperature Cycle	Storage	-10°C(1Hr)→25°C(5min)→60°C(1Hr) 32 Cycles	Note
		Operation	-20°C(1Hr)→25°C(5min)→60°C(1Hr) 25 Cycles	
5	Peeling Off (Storage)	≥ 500gf/cm	Note	
6	FPC Bending Test	≥ 6,000 times, 2/sec	Note	
7	Vibration Test(Storage)	50HZ, 30min, Amplitude: 2 cm, X/Y/Z directions	Note	
8	Drop Test	60cm/ 3Corner/ 8Face, 1Cycle	Note	

Note:

- 1) The test samples should be applied to only one test item.
- 2) Sample size for each test item is 5~10pcs.
- 3) For Damp Proof Test, pure water(Resistance>1MΩ) should be used.
- 4) In case of malfunction defect caused by ESD damage, if it would be recovered to normal state after resetting, it would be judged as a good part.
- 5) EL evaluation should be excepted from reliability test with humidity and temperature: Some defects such as black spot/blemish can happen by natural chemical reaction with humidity and fluorescence EL has.
- 6) After the reliability test, the test samples should be inspected after 2 hours at least.
- 7) Functional test is OK. Missing segment, shorts, unclear segment, non display, display abnormally, liquid crystal leak are not allowed.
- 8) After testing, the current I_{dd} should be within initial value ±20%.
- 9) No low temperature bubbles, end seal loose and fall, frame rainbow, ACF bubble growing are allowable in the appearance test.

11. Inspection Criterion

11.1. Sampling Method

Unless otherwise agreed upon in writing, the sampling inspection shall be applied to the Customer's incoming inspection.

- 1) Lot size: Quantity per shipment lot
- 2) Sampling type: Normal inspection , single sampling
- 3) Inspection level: II
- 4) Sampling table: MIL-STD-105D
- 5) Acceptable Quality Level(AQL): Major=0.65 Minor=1.5

11.2. Inspection Method

- 1) Ambient Condition:
 - a. Temperature: Room temperature 25±5°C
 - b. Illumination: Single fluorescent lamp non-directive(300 to 700 Lux)
- 2) Viewing distance
The distance between the LCD and the inspector' s eyes shall be at least 30-50cm.
- 3) Viewing Angle
The inspection shall be conducted within normal viewing angle range.

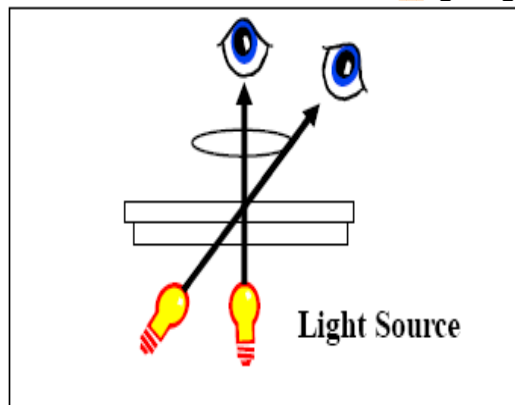



11.3. Inspection Criteria

11.3.1. Major defect

No.	Item	Inspection Standard	Classification of defects
1	All functional defects	1) No display 2) Display abnormally 3) Open or missing segment 4) Short circuit 5) Excess power consumption 6) Backlight no lighting, flickering and abnormal lighting	Major
2	Missing	Missing component	Major
3	Outline dimension	Overall outline dimension beyond the drawing is not allowed	Major

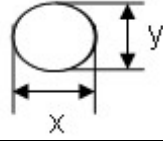
11.3.2. Cosmetic Defect

No.	Item	Inspection Standard		Classification of defects							
1	(spot defect) Black and White spot pinhole	For dark/white spot, size Φ is defined as $\Phi=(x+y)/2$		Minor							
		<table border="1"> <thead> <tr> <th>Size Φ (mm)</th> <th>Acceptable Quantity</th> </tr> </thead> <tbody> <tr> <td>$\Phi \leq 0.1$</td> <td>Ignore</td> </tr> <tr> <td>$0.10 < \Phi \leq 0.15$</td> <td>2</td> </tr> <tr> <td>$0.15 < \Phi \leq 0.2$</td> <td>1</td> </tr> <tr> <td>$0.2 < \Phi$</td> <td>0</td> </tr> </tbody> </table>	Size Φ (mm)		Acceptable Quantity	$\Phi \leq 0.1$	Ignore	$0.10 < \Phi \leq 0.15$	2	$0.15 < \Phi \leq 0.2$	1
Size Φ (mm)	Acceptable Quantity										
$\Phi \leq 0.1$	Ignore										
$0.10 < \Phi \leq 0.15$	2										
$0.15 < \Phi \leq 0.2$	1										
$0.2 < \Phi$	0										
2	(line defect) Black and White line Polarizer scratch	Define: 		Minor							
		<table border="1"> <thead> <tr> <th>Width(mm)</th> <th>Length(mm); Acceptable Qty</th> </tr> </thead> <tbody> <tr> <td>$\Phi \leq 0.03$</td> <td>Ignore</td> </tr> <tr> <td>$0.03 < W \leq 0.05$</td> <td>$L \leq 3.0$; $N \leq 2$</td> </tr> <tr> <td>$0.05 < W \leq 0.1$</td> <td>$L \leq 2.0$; $N \leq 2$</td> </tr> <tr> <td>$0.1 < W$</td> <td>Define as spot defect</td> </tr> </tbody> </table>	Width(mm)		Length(mm); Acceptable Qty	$\Phi \leq 0.03$	Ignore	$0.03 < W \leq 0.05$	$L \leq 3.0$; $N \leq 2$	$0.05 < W \leq 0.1$	$L \leq 2.0$; $N \leq 2$
Width(mm)	Length(mm); Acceptable Qty										
$\Phi \leq 0.03$	Ignore										
$0.03 < W \leq 0.05$	$L \leq 3.0$; $N \leq 2$										
$0.05 < W \leq 0.1$	$L \leq 2.0$; $N \leq 2$										
$0.1 < W$	Define as spot defect										
3	Polarizer defect	Dent or bubble(between the polarizer and glass)		Minor							
		<table border="1"> <thead> <tr> <th>Size Φ(mm)</th> <th>Acceptable Qty</th> </tr> </thead> <tbody> <tr> <td>$\Phi \leq 0.10$</td> <td>Ignor</td> </tr> <tr> <td>$0.10 < \Phi \leq 0.20$</td> <td>2</td> </tr> <tr> <td>$0.20 < \Phi \leq 0.30$</td> <td>1</td> </tr> <tr> <td>$0.30 < \Phi$</td> <td>0</td> </tr> </tbody> </table>	Size Φ (mm)		Acceptable Qty	$\Phi \leq 0.10$	Ignor	$0.10 < \Phi \leq 0.20$	2	$0.20 < \Phi \leq 0.30$	1
Size Φ (mm)	Acceptable Qty										
$\Phi \leq 0.10$	Ignor										
$0.10 < \Phi \leq 0.20$	2										
$0.20 < \Phi \leq 0.30$	1										
$0.30 < \Phi$	0										

11.3.3. Cosmetic Defect

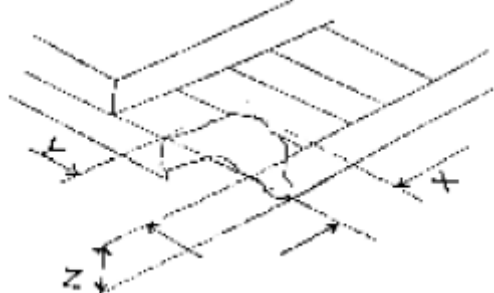
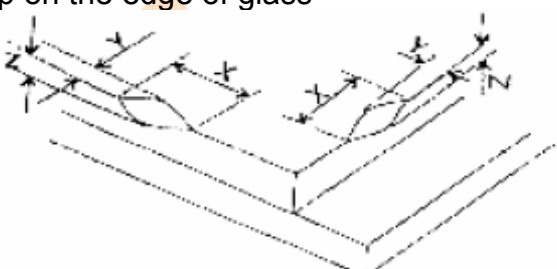
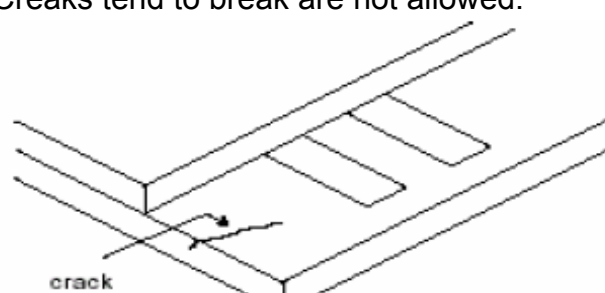
No.	Item	Inspection Standard	Classification of defects						
1	Glass defect	<p>1) Chip on the corner</p>  <table border="1" data-bbox="486 683 1189 795"> <tr> <td>X</td> <td>Y</td> <td>Z</td> </tr> <tr> <td>≤3.0</td> <td>≤S</td> <td>≤T</td> </tr> </table> <p>Remark: S=contact pad length; T=the thickness of glass</p> <p>Chips on the corner of terminal shall not be allowed to extend into the ITO pad or expose perimeter seal. Acceptable Quantity N≤2.</p>	X	Y	Z	≤3.0	≤S	≤T	Minor
		X	Y	Z					
		≤3.0	≤S	≤T					
<p>2) Chip on the edge of glass</p>  <table border="1" data-bbox="486 1400 1189 1512"> <tr> <td>X</td> <td>Y</td> <td>Z</td> </tr> <tr> <td>Ignore</td> <td>≤0.5</td> <td>≤T</td> </tr> </table> <p>Acceptable Quantity: N≤2</p>	X	Y	Z	Ignore	≤0.5	≤T	Minor		
X	Y	Z							
Ignore	≤0.5	≤T							
<p>3) Creak</p> <p>Creaks tend to break are not allowed.</p> 	Minor								



JEWEL HILL

12. PACKAGE INFORMATION.

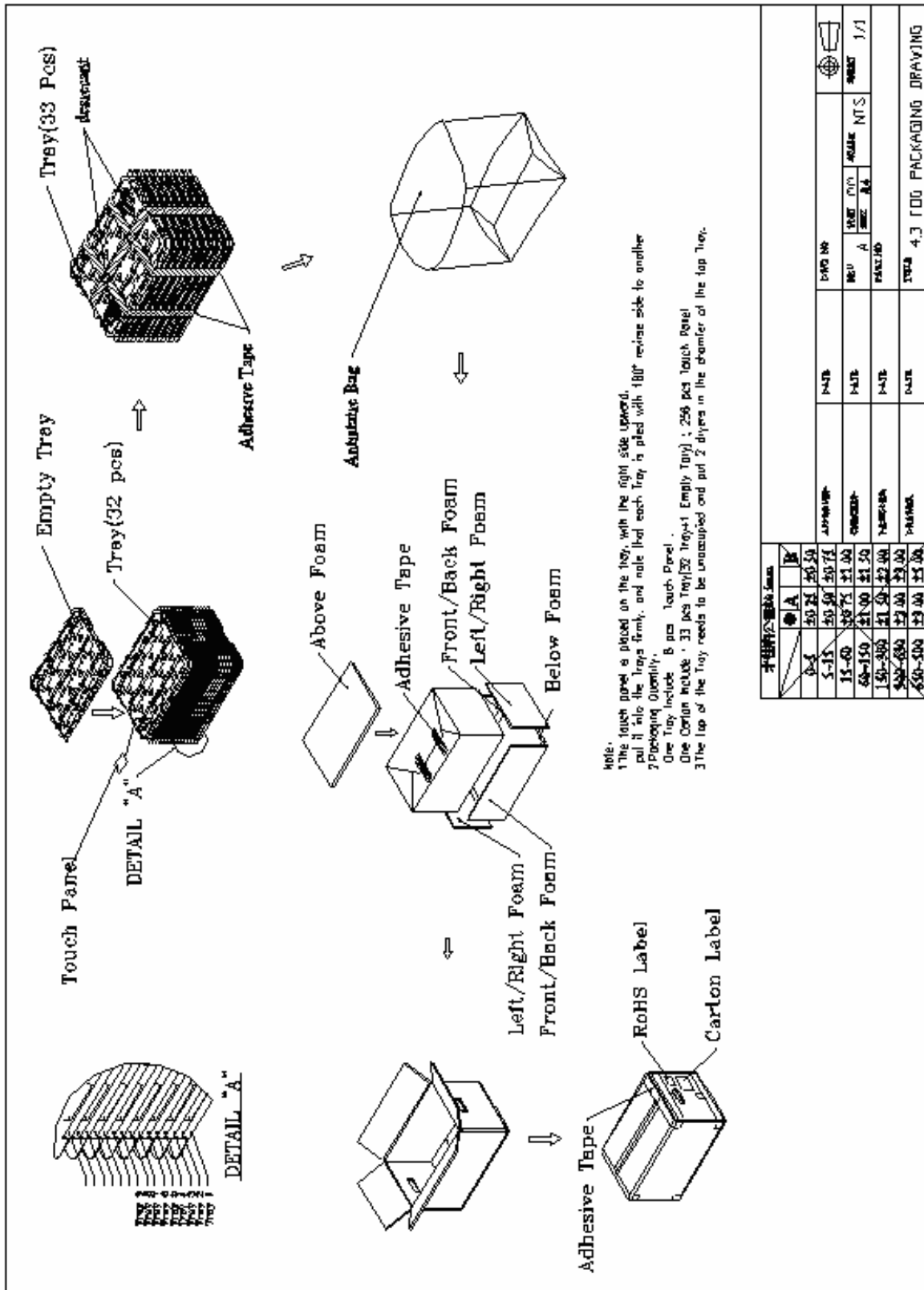

13.ROHS COMPLIANT WARRANTY.

RoHs Hazardous substances including:

- Cd< 100 ppm
- Pb< 1000 ppm
- Hg< 1000 ppm
- Cr +6 < 1000 ppm
- PBDE < 1000 ppm
- PBB < 1000 ppm

JEWEL HILL

14.PRECAUTIONS FOR USING LCD MODULES

Handing Precautions

- (1) The display panel is made of glass and polarizer. As glass is fragile, it tends to become or chipped during handling especially on the edges. Please avoid dropping or jarring. Do not subject it to a mechanical shock by dropping it or impact.
- (2) If the display panel is damaged and the liquid crystal substance leaks out, be sure not to get any in your mouth. If the substance contacts your skin or clothes, wash it off using soap and water.
- (3) Do not apply excessive force to the display surface or the adjoining areas since this may cause the color tone to vary. Do not touch the display with bare hands. This will stain the display area and degraded insulation between terminals (some cosmetics are determined to the polarizer).
- (4) The polarizer covering the display surface of the LCD module is soft and easily scratched. Handle this polarizer carefully. Do not touch, push or rub the exposed polarizers with anything harder than an HB pencil lead (glass, tweezers, etc.). Do not put or attach anything on the display area to avoid leaving marks on. Condensation on the surface and contact with terminals due to cold will damage, stain or dirty the polarizer. After products are tested at low temperature they must be warmed up in a container before coming is contacting with room temperature air.
- (5) If the display surface becomes contaminated, breathe on the surface and gently wipe it with a soft dry cloth. If it is heavily contaminated, moisten cloth with one of the following solvents
 - Isopropyl alcohol
 - Ethyl alcoholDo not scrub hard to avoid damaging the display surface.
- (6) Solvents other than those above-mentioned may damage the polarizer. Especially, do not use the following.
 - Water
 - Ketone
 - Aromatic solventsWipe off saliva or water drops immediately, contact with water over a long period of time may cause deformation or color fading. Avoid contacting oil and fats.
- (7) Exercise care to minimize corrosion of the electrode. Corrosion of the electrodes is accelerated by water droplets, moisture condensation or a current flow in a high-humidity environment.
- (8) Install the LCD Module by using the mounting holes. When mounting the LCD module make sure it is free of twisting, warping and distortion. In particular, do not forcibly pull or bend the I/O cable or the backlight cable.
- (9) Do not attempt to disassemble or process the LCD module.

- (10) NC terminal should be open. Do not connect anything.
- (11) If the logic circuit power is off, do not apply the input signals.
- (12) Since LCM has been assembled and adjusted with a high degree of precision, avoid applying excessive shocks to the module or making any alterations or modifications to it.
 - Do not alter, modify or change the shape of the tab on the metal frame.
 - Do not make extra holes on the printed circuit board, modify its shape or change the positions of components to be attached.
 - Do not damage or modify the pattern writing on the printed circuit board.
 - Absolutely do not modify the zebra rubber strip (conductive rubber) or heat seal connector.
 - Except for soldering the interface, do not make any alterations or modifications with a soldering iron.
 - Do not drop, bend or twist LCM.

Storage Precautions

When storing the LCD modules, the following precaution is necessary.

- (1) Store them in a sealed polyethylene bag. If properly sealed, there is no need for the dessicant.
- (2) Store them in a dark place. Do not expose to sunlight or fluorescent light, keep the temperature between 0°C and 35°C.
- (3) The polarizer surface should not come in contact with any other objects. (We advise you to store them in the container in which they were shipped).

Others

Liquid crystals solidify under low temperature (below the storage temperature range) leading to defective orientation or the generation of air bubbles (black or white). Air bubbles may also be generated if the module is subject to a low temperature.

If the LCD modules have been operating for a long time showing the same display patterns, the display patterns may remain on the screen as ghost images and a slight contrast irregularity may also appear. A normal operating status can be regained by suspending use for some time. It should be noted that this phenomenon does not adversely affect performance reliability.

To minimize the performance degradation of the LCD modules resulting from destruction caused by static electricity etc., exercise care to avoid holding the following sections when handling the modules.

- Exposed area of the printed circuit board.
- Terminal electrode sections.

15. REVISION HISTORY.

**(样品确认单)**

SAMPLE MODEL NO. (样品型号)	JH395320480D
SAMPLE SERIES NUMBER NO. (样品序号)	
SAMPLE QUANTITY (样品数量)	
COLOR/TYPE (底色/类型)	TFT/NEGATIVE
VIEWING DIRECTION (视角)	12H
DRIVING METHOD (驱动参数)	1/480DUTY
LOGIC VOLTAGE (工作电压)	2.8V
LCD VOP (LCD 驱动电压)	
OPERATING TEMP. (操作温度) °C	-20 ~ 70°C
STORAGE TEMP. (储存温度) °C	-30 ~ 80°C
POLARIZER----FRONT (首偏光片)	
POLARIZER----BACK (后偏光片)	TRANSMISSIVE
CONTROLLER/DRIVER IC(控制/驱动 IC)	ILI9486L(COG)
BACKLIGHT COLOR/TYPE (背光源类型/颜色)	WHITE
DRAWING REV/NO./QUANTITY (图纸版本/数量)	
SPECIFICATION (规格书 份数)	
REMARKS: (备注)	
WRIT BY: _____ DATE: _____ APROV BY: _____ DATE: _____	
CUSTOMER'S APPROVAL (客户确认):	
1) FUNCTION (功能):	<input type="checkbox"/> OK <input type="checkbox"/> N.G.
2) DRIVER CONDITION (驱动条件):	<input type="checkbox"/> OK <input type="checkbox"/> N.G.
3) DISPLAY MODE (显示模式):	<input type="checkbox"/> OK <input type="checkbox"/> N.G.
4) VIEWING ANGLE (视角):	<input type="checkbox"/> OK <input type="checkbox"/> N.G.
5) BACKLIGHT (背光源):	<input type="checkbox"/> OK <input type="checkbox"/> N.G.
6) DISPLAYING PATTERN (显示效果):	<input type="checkbox"/> OK <input type="checkbox"/> N.G.
CUSTOMER'S CONCLUSIONS (客户意见): _____	

CUSTOMER'S SIGNATURE (客户签名): _____ DATE (日期): _____	